

CELLA



04

SIZES



09 - 40

WATTS



04

BEAM ANGLES



IP 20
IP 44

INGRESS

CELLA

recessed luminaires
square | fixed

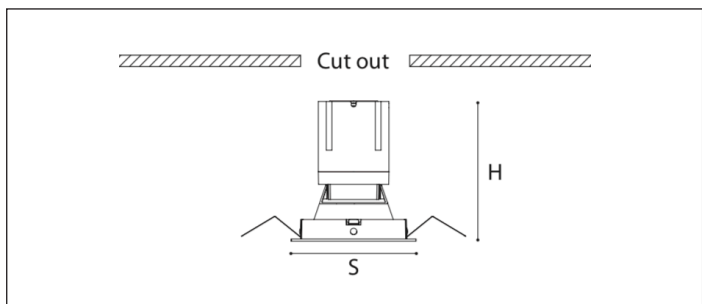

Dimensions (mm)

	L	B	H	Cut Out
Size 1	90	90	100	75 x 75
Size 2	115	115	130	100 x 100
Size 3	140	140	150	125 x 125
Size 4	165	165	175	150 x 150

Cella adjustable 'square' downlight collection offers multiple options to choose from wattages ranging between 9W - 40W in all standard symmetric beam options and as made available across 4 varied size options to adopt to site requirements within the standard color spectrum.

Special IP44 versions can also be offered on request.

CCT of 5000K and 6000K are also available on request.

Standard protocol for fixed output driver is offered in our article coding. Dimmable driver options are available on request.

Technical Data

CREE **bridgelux** **EPISTAR**

Body	Die Cast Aluminium
LED Type	COB
Colour Deviation	<2 SDCM
Colour Rendering Index	+90
Lumen Maintenance	L90 / B10 50000 hours
Driver	Integral
Dimmability	DALI (on request)
IP Rating	IP 20 & IP 44 (on request)
Protection Class	Class II

Certifications



Available Options











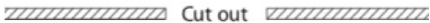

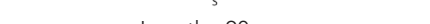
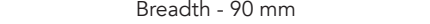
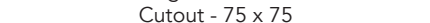



















Light Distribution		Watt	Lumen	Colour Temp	Finishes
15 deg	Spot (S)	9	720	2700 K	White
	38 deg	12	960		
24 deg	Medium (M)	15	1200	3000 K	Black
		20	1600		
	25	2000			
	30	2400			
	35	2800			
40	3200	4000 K	White - Black		
Wall Wash	Wash (WW)				

AEWIS

We reserve the right for technical and design changes
For latest product update please refer www.aewis.com

CELLA

recessed luminaires
square | fixed

Size 1	Article Reference	Finish	Watt	Lumen	Colour Temp	Beam Angle
	CE 111 009 2 S	White	9	720 lm	2700 K	15 deg
	CE 111 009 3 S	White	9	720 lm	3000 K	15 deg
	CE 111 009 4 S	White	9	720 lm	4000 K	15 deg
	CE 121 009 2 S	Black	9	720 lm	2700 K	15 deg
	CE 121 009 3 S	Black	9	720 lm	3000 K	15 deg
	CE 121 009 4 S	Black	9	720 lm	4000 K	15 deg
	CE 131 009 2 S	White - Black	9	720 lm	2700 K	15 deg
	CE 131 009 3 S	White - Black	9	720 lm	3000 K	15 deg
	CE 131 009 4 S	White - Black	9	720 lm	4000 K	15 deg
	CE 111 009 2 M	White	9	720 lm	2700 K	38 deg
	CE 111 009 3 M	White	9	720 lm	3000 K	38 deg
	CE 111 009 4 M	White	9	720 lm	4000 K	38 deg
	CE 121 009 2 M	Black	9	720 lm	2700 K	38 deg
	CE 121 009 3 M	Black	9	720 lm	3000 K	38 deg
	CE 121 009 4 M	Black	9	720 lm	4000 K	38 deg
	CE 131 009 2 M	White - Black	9	720 lm	2700 K	38 deg
	CE 131 009 3 M	White - Black	9	720 lm	3000 K	38 deg
	CE 131 009 4 M	White - Black	9	720 lm	4000 K	38 deg
	CE 111 012 2 S	White	12	960 lm	2700 K	15 deg
	CE 111 012 3 S	White	12	960 lm	3000 K	15 deg
	CE 111 012 4 S	White	12	960 lm	4000 K	15 deg
	CE 121 012 2 S	Black	12	960 lm	2700 K	15 deg
	CE 121 012 3 S	Black	12	960 lm	3000 K	15 deg
	CE 121 012 4 S	Black	12	960 lm	4000 K	15 deg
	CE 131 012 2 S	White - Black	12	960 lm	2700 K	15 deg
	CE 131 012 3 S	White - Black	12	960 lm	3000 K	15 deg
	CE 131 012 4 S	White - Black	12	960 lm	4000 K	15 deg
	CE 111 012 2 M	White	12	960 lm	2700 K	38 deg
	CE 111 012 3 M	White	12	960 lm	3000 K	38 deg
	CE 111 012 4 M	White	12	960 lm	4000 K	38 deg
	CE 121 012 2 M	Black	12	960 lm	2700 K	38 deg
	CE 121 012 3 M	Black	12	960 lm	3000 K	38 deg
	CE 121 012 4 M	Black	12	960 lm	4000 K	38 deg
	CE 131 012 2 M	White - Black	12	960 lm	2700 K	38 deg
	CE 131 012 3 M	White - Black	12	960 lm	3000 K	38 deg
	CE 131 012 4 M	White - Black	12	960 lm	4000 K	38 deg

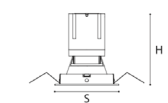











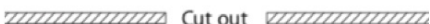

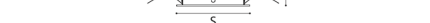
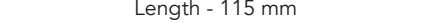
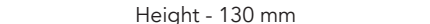



















Length - 90 mm
Breadth - 90 mm
Height - 100 mm
Cutout - 75 x 75

AEWIS

We reserve the right for technical and design changes
For latest product update please refer www.aewis.com

CELLA

recessed luminaires
square | fixed

Size 2	Article Reference	Finish	Watt	Lumen	Colour Temp	Beam Angle
	CE 112 015 2 S	White	15	1200 lm	2700 K	15 deg
	CE 112 015 3 S	White	15	1200 lm	3000 K	15 deg
	CE 112 015 4 S	White	15	1200 lm	4000 K	15 deg
	CE 122 015 2 S	Black	15	1200 lm	2700 K	15 deg
	CE 122 015 3 S	Black	15	1200 lm	3000 K	15 deg
	CE 122 015 4 S	Black	15	1200 lm	4000 K	15 deg
	CE 132 015 2 S	White - Black	15	1200 lm	2700 K	15 deg
	CE 132 015 3 S	White - Black	15	1200 lm	3000 K	15 deg
	CE 132 015 4 S	White - Black	15	1200 lm	4000 K	15 deg
	CE 112 015 2 M	White	15	1200 lm	2700 K	38 deg
	CE 112 015 3 M	White	15	1200 lm	3000 K	38 deg
	CE 112 015 4 M	White	15	1200 lm	4000 K	38 deg
	CE 122 015 2 M	Black	15	1200 lm	2700 K	38 deg
	CE 122 015 3 M	Black	15	1200 lm	3000 K	38 deg
	CE 122 015 4 M	Black	15	1200 lm	4000 K	38 deg
	CE 132 015 2 M	White - Black	15	1200 lm	2700 K	38 deg
	CE 132 015 3 M	White - Black	15	1200 lm	3000 K	38 deg
	CE 132 015 4 M	White - Black	15	1200 lm	4000 K	38 deg
	CE 112 020 2 S	White	20	1600 lm	2700 K	15 deg
	CE 112 020 3 S	White	20	1600 lm	3000 K	15 deg
	CE 112 020 4 S	White	20	1600 lm	4000 K	15 deg
	CE 122 020 2 S	Black	20	1600 lm	2700 K	15 deg
	CE 122 020 3 S	Black	20	1600 lm	3000 K	15 deg
	CE 122 020 4 S	Black	20	1600 lm	4000 K	15 deg
	CE 132 020 2 S	White - Black	20	1600 lm	2700 K	15 deg
	CE 132 020 3 S	White - Black	20	1600 lm	3000 K	15 deg
	CE 132 020 4 S	White - Black	20	1600 lm	4000 K	15 deg
	CE 112 020 2 M	White	20	1600 lm	2700 K	38 deg
	CE 112 020 3 M	White	20	1600 lm	3000 K	38 deg
	CE 112 020 4 M	White	20	1600 lm	4000 K	38 deg
	CE 122 020 2 M	Black	20	1600 lm	2700 K	38 deg
	CE 122 020 3 M	Black	20	1600 lm	3000 K	38 deg
	CE 122 020 4 M	Black	20	1600 lm	4000 K	38 deg
	CE 132 020 2 M	White - Black	20	1600 lm	2700 K	38 deg
	CE 132 020 3 M	White - Black	20	1600 lm	3000 K	38 deg
	CE 132 020 4 M	White - Black	20	1600 lm	4000 K	38 deg

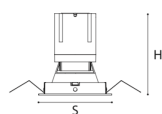







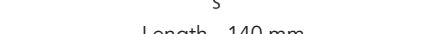

Length - 115 mm
Breadth - 115 mm
Height - 130 mm
Cutout - 100 x 100

AEWIS

We reserve the right for technical and design changes
For latest product update please refer www.aewis.com

CELLA

recessed luminaires
square | fixed

Size 3	Article Reference	Finish	Watt	Lumen	Colour Temp	Beam Angle
	CE 113 025 2 S	White	25	2000 lm	2700 K	15 deg
	CE 113 025 3 S	White	25	2000 lm	3000 K	15 deg
	CE 113 025 4 S	White	25	2000 lm	4000 K	15 deg
	CE 123 025 2 S	Black	25	2000 lm	2700 K	15 deg
	CE 123 025 3 S	Black	25	2000 lm	3000 K	15 deg
	CE 123 025 4 S	Black	25	2000 lm	4000 K	15 deg
	CE 133 025 2 S	White - Black	25	2000 lm	2700 K	15 deg
	CE 133 025 3 S	White - Black	25	2000 lm	3000 K	15 deg
	CE 133 025 4 S	White - Black	25	2000 lm	4000 K	15 deg
	CE 113 025 2 M	White	25	2000 lm	2700 K	38 deg
	CE 113 025 3 M	White	25	2000 lm	3000 K	38 deg
	CE 113 025 4 M	White	25	2000 lm	4000 K	38 deg
	CE 123 025 2 M	Black	25	2000 lm	2700 K	38 deg
	CE 123 025 3 M	Black	25	2000 lm	3000 K	38 deg
	CE 123 025 4 M	Black	25	2000 lm	4000 K	38 deg
	CE 133 025 2 M	White - Black	25	2000 lm	2700 K	38 deg
	CE 133 025 3 M	White - Black	25	2000 lm	3000 K	38 deg
	CE 133 025 4 M	White - Black	25	2000 lm	4000 K	38 deg
	CE 113 030 2 S	White	30	2400 lm	2700 K	15 deg
	CE 113 030 3 S	White	30	2400 lm	3000 K	15 deg
	CE 113 030 4 S	White	30	2400 lm	4000 K	15 deg
	CE 123 030 2 S	Black	30	2400 lm	2700 K	15 deg
	CE 123 030 3 S	Black	30	2400 lm	3000 K	15 deg
	CE 123 030 4 S	Black	30	2400 lm	4000 K	15 deg
	CE 133 030 2 S	White - Black	30	2400 lm	2700 K	15 deg
	CE 133 030 3 S	White - Black	30	2400 lm	3000 K	15 deg
	CE 133 030 4 S	White - Black	30	2400 lm	4000 K	15 deg
	CE 113 030 2 M	White	30	2400 lm	2700 K	38 deg
	CE 113 030 3 M	White	30	2400 lm	3000 K	38 deg
	CE 113 030 4 M	White	30	2400 lm	4000 K	38 deg
	CE 123 030 2 M	Black	30	2400 lm	2700 K	38 deg
	CE 123 030 3 M	Black	30	2400 lm	3000 K	38 deg
	CE 123 030 4 M	Black	30	2400 lm	4000 K	38 deg
	CE 133 030 2 M	White - Black	30	2400 lm	2700 K	38 deg
	CE 133 030 3 M	White - Black	30	2400 lm	3000 K	38 deg
	CE 133 030 4 M	White - Black	30	2400 lm	4000 K	38 deg

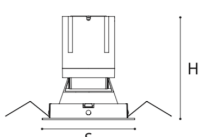











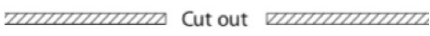

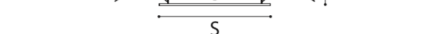
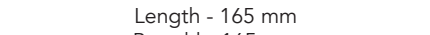
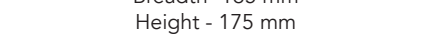

Length - 140 mm
Breadth - 140 mm
Height - 150 mm
Cutout - 125 x 125

AEWIS

We reserve the right for technical and design changes
For latest product update please refer www.aewis.com

CELLA

recessed luminaires
square | fixed

Size 4	Article Reference	Finish	Watt	Lumen	Colour Temp	Beam Angle
	CE 114 035 2 S	White	35	2800 lm	2700 K	15 deg
	CE 114 035 3 S	White	35	2800 lm	3000 K	15 deg
	CE 114 035 4 S	White	35	2800 lm	4000 K	15 deg
	CE 124 035 2 S	Black	35	2800 lm	2700 K	15 deg
	CE 124 035 3 S	Black	35	2800 lm	3000 K	15 deg
	CE 124 035 4 S	Black	35	2800 lm	4000 K	15 deg
	CE 134 035 2 S	White - Black	35	2800 lm	2700 K	15 deg
	CE 134 035 3 S	White - Black	35	2800 lm	3000 K	15 deg
	CE 134 035 4 S	White - Black	35	2800 lm	4000 K	15 deg
	CE 114 035 2 M	White	35	2800 lm	2700 K	38 deg
	CE 114 035 3 M	White	35	2800 lm	3000 K	38 deg
	CE 114 035 4 M	White	35	2800 lm	4000 K	38 deg
	CE 124 035 2 M	Black	35	2800 lm	2700 K	38 deg
	CE 124 035 3 M	Black	35	2800 lm	3000 K	38 deg
	CE 124 035 4 M	Black	35	2800 lm	4000 K	38 deg
	CE 134 035 2 M	White - Black	35	2800 lm	2700 K	38 deg
	CE 134 035 3 M	White - Black	35	2800 lm	3000 K	38 deg
	CE 134 035 4 M	White - Black	35	2800 lm	4000 K	38 deg
	CE 114 040 2 S	White	40	3200 lm	2700 K	15 deg
	CE 114 040 3 S	White	40	3200 lm	3000 K	15 deg
	CE 114 040 4 S	White	40	3200 lm	4000 K	15 deg
	CE 124 040 2 S	Black	40	3200 lm	2700 K	15 deg
	CE 124 040 3 S	Black	40	3200 lm	3000 K	15 deg
	CE 124 040 4 S	Black	40	3200 lm	4000 K	15 deg
	CE 134 040 2 S	White - Black	40	3200 lm	2700 K	15 deg
	CE 134 040 3 S	White - Black	40	3200 lm	3000 K	15 deg
	CE 134 040 4 S	White - Black	40	3200 lm	4000 K	15 deg
	CE 114 040 2 M	White	40	3200 lm	2700 K	38 deg
	CE 114 040 3 M	White	40	3200 lm	3000 K	38 deg
	CE 114 040 4 M	White	40	3200 lm	4000 K	38 deg
	CE 124 040 2 M	Black	40	3200 lm	2700 K	38 deg
	CE 124 040 3 M	Black	40	3200 lm	3000 K	38 deg
	CE 124 040 4 M	Black	40	3200 lm	4000 K	38 deg
	CE 134 040 2 M	White - Black	40	3200 lm	2700 K	38 deg
	CE 134 040 3 M	White - Black	40	3200 lm	3000 K	38 deg
	CE 134 040 4 M	White - Black	40	3200 lm	4000 K	38 deg

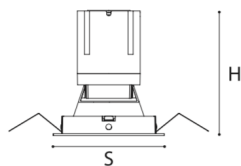

Length - 165 mm
Breadth - 165 mm
Height - 175 mm
Cutout - 150 x 150

AEWIS

We reserve the right for technical and design changes
For latest product update please refer www.aewis.com

CELLA

recessed luminaires
square | fixed

Light Distribution Curves

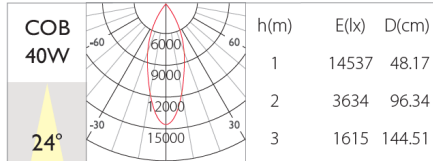
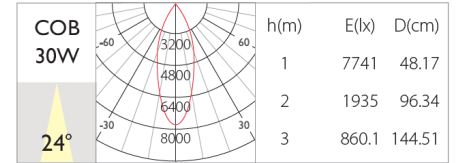
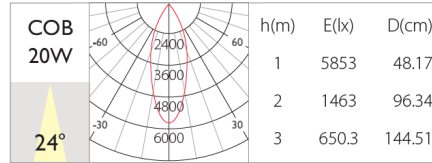
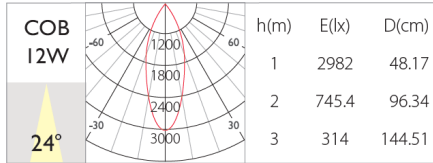

AEWIS

We reserve the right for technical and design changes
For latest product update please refer www.aewis.com