



## FJORD



SIZES



WATTS



BEAM ANGLES



INGRESS

# FJORD

recessed luminaires  
square | fixed

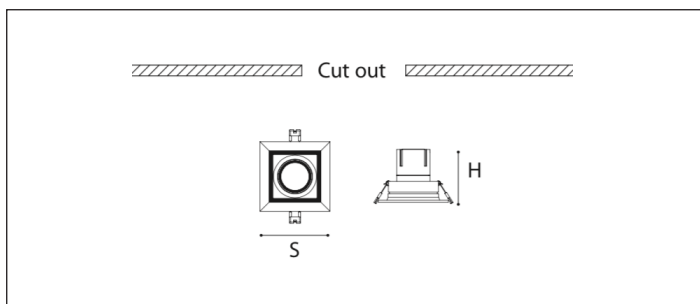

Fjord adjustable 'square' downlight collection offers multiple options to choose from wattages ranging between 9W - 105W in all standard symmetric beam options and as made available across 3 varied size options to adopt to site requirements with 'single', 'double' and 'triple' configurations' within the standard color spectrum. The complete range is IP20 suitable for indoor applications as offered.

CCT of 5000K and 6000K are also available on request.

Standard protocol for fixed output driver is offered in our article coding. Dimmable driver options are available on request.

### Technical Data

**CREE** **bridgelux** **EPISTAR**

Body	Die Cast Aluminium
LED Type	COB
Colour Deviation	<2 SDCM
Colour Rendering Index	+90
Lumen Maintenance	L90 / B10 50000 hours
Driver	Integral
Dimmability	DALI (on request)
IP Rating	IP 20
Protection Class	Class II

### Dimensions (mm)

	L	B	H	Cut Out
Size 1	116	116	88	100 x 100
Size 2	144	144	108	125 x 125
Size 3	164	164	128	145 x 145
Size 4	184	184	135	165 x 165

### Certifications



### Available Options

Light Distribution		Watt	Lumen	Colour Temp	Finishes
15 deg	Spot (S)	9	765	3000 K	Black
	60 deg Flood (F)				
24 deg	Medium (M)	25	2125	4000 K	White - Black
	Wall Wash Wash (WW)				
38 deg	Medium (M)	35	2975		

## AEWIS

We reserve the right for technical and design changes  
For latest product update please refer [www.aewis.com](http://www.aewis.com)

# FJORD

recessed luminaires  
square | fixed

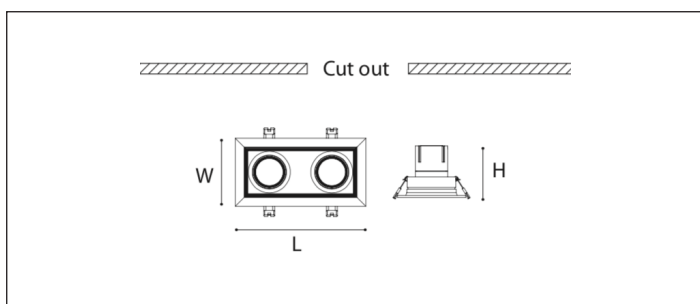

Fjord adjustable 'square' downlight collection offers multiple options to choose from wattages ranging between 9W - 105W in all standard symmetric beam options and as made available across 3 varied size options to adopt to site requirements with 'single', 'double' and 'triple' configurations' within the standard color spectrum. The complete range is IP20 suitable for indoor applications as offered.

CCT of 5000K and 6000K are also available on request.

Standard protocol for fixed output driver is offered in our article coding. Dimmable driver options are available on request.

## Technical Data

**CREE** **bridgelux** **EPISTAR**

Body	Die Cast Aluminium
LED Type	COB
Colour Deviation	<2 SDCM
Colour Rendering Index	+90
Lumen Maintenance	L90 / B10 50000 hours
Driver	Integral
Dimmability	DALI (on request)
IP Rating	IP 20
Protection Class	Class II

## Dimensions (mm)

	L	B	H	Cut Out
Size 1	221	116	88	100 x 200
Size 2	272	144	108	125 x 250
Size 3	313	164	128	145 x 290
Size 4	354	184	135	165 x 330

## Certifications



## Available Options

Light Distribution		Watt	Lumen	Colour Temp	Finishes
15 deg	Spot (S)	2 x 9	1530	2700 K	White
	60 deg Flood(F)	2 x 15	2550		
24 deg	Medium (M)	2 x 25	4250	3000 K	Black
	Wall Wash	2 x 35	5950		
38 deg	Medium (M)			4000 K	White - Black

## AEWIS

We reserve the right for technical and design changes  
For latest product update please refer [www.aewis.com](http://www.aewis.com)

# FJORD

recessed luminaires  
square | fixed

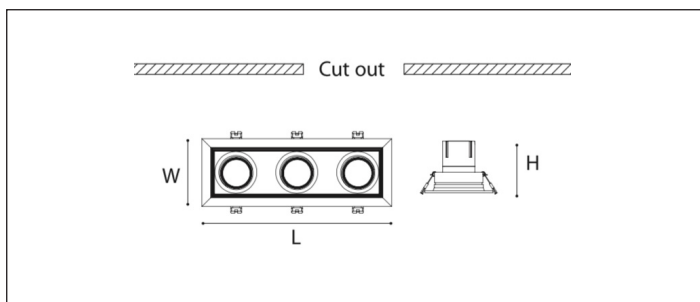

Fjord adjustable 'square' downlight collection offers multiple options to chose from wattages ranging between 9W - 105W in all standard symmetric beam options and as made available across 3 varied size options to adopt to site requirements with 'single', 'double' and 'triple' configurations' within the standard color spectrum. The complete range is IP20 suitable for indoor applications as offered.

CCT of 5000K and 6000K are also available on request.

Standard protocol for fixed output driver is offered in our article coding. Dimmable driver options are available on request.

## Technical Data

**CREE** **bridgelux** **EPISTAR**

Body	Die Cast Aluminium
LED Type	COB
Colour Deviation	<2 SDCM
Colour Rendering Index	+90
Lumen Maintenance	L90 / B10 50000 hours
Driver	Integral
Dimmability	DALI (on request)
IP Rating	IP 20
Protection Class	Class II

## Dimensions (mm)

	L	B	H	Cut Out
Size 1	324	116	88	100 x 300
Size 2	400	144	108	125 x 375
Size 3	462	164	128	145 x 440
Size 4	524	184	135	165 x 500

## Certifications



## Available Options

Light Distribution		Watt	Lumen	Colour Temp	Finishes
15 deg	Spot (S)	3 x 9	2295	2700 K	White
	60 deg	Flood (F)	3 x 15		
24 deg	Medium (M)	3 x 25	6375	3000 K	Black
	Wall Wash	Wash (WW)	3 x 35		
38 deg	Medium (M)			4000 K	White Black

## AEWIS

We reserve the right for technical and design changes  
For latest product update please refer [www.aewis.com](http://www.aewis.com)

# FJORD

recessed luminaires  
square | fixed

Size 1	Article Reference	Finish	Watt	Lumen	Colour Temp	Beam Angle
  <p>Length - 144 mm Breadth - 144 mm Height - 108 mm Cutout - 125 x 125</p>	FJ 111 015 2 S	White	15	1275 lm	2700 K	15 deg
	FJ 111 015 3 S	White	15	1275 lm	3000 K	15 deg
	FJ 111 015 4 S	White	15	1275 lm	4000 K	15 deg
	FJ 121 015 2 S	Black	15	1275 lm	2700 K	15 deg
	FJ 121 015 3 S	Black	15	1275 lm	3000 K	15 deg
	FJ 121 015 4 S	Black	15	1275 lm	4000 K	15 deg
	FJ 131 015 2 S	White - Black	15	1275 lm	2700 K	15 deg
	FJ 131 015 3 S	White - Black	15	1275 lm	3000 K	15 deg
	FJ 131 015 4 S	White - Black	15	1275 lm	4000 K	15 deg
	FJ 111 015 2 M	White	15	1275 lm	2700 K	38 deg
	FJ 111 015 3 M	White	15	1275 lm	3000 K	38 deg
	FJ 111 015 4 M	White	15	1275 lm	4000 K	38 deg
	FJ 121 015 2 M	Black	15	1275 lm	2700 K	38 deg
	FJ 121 015 3 M	Black	15	1275 lm	3000 K	38 deg
	FJ 121 015 4 M	Black	15	1275 lm	4000 K	38 deg
	FJ 131 015 2 M	White - Black	15	1275 lm	2700 K	38 deg
	FJ 131 015 3 M	White - Black	15	1275 lm	3000 K	38 deg
	FJ 131 015 4 M	White - Black	15	1275 lm	4000 K	38 deg
	FJ 111 015 2 F	White	15	1275 lm	2700 K	60 deg
	FJ 111 015 3 F	White	15	1275 lm	3000 K	60 deg
	FJ 111 015 4 F	White	15	1275 lm	4000 K	60 deg
	FJ 121 015 2 F	Black	15	1275 lm	2700 K	60 deg
	FJ 121 015 3 F	Black	15	1275 lm	3000 K	60 deg
	FJ 121 015 4 F	Black	15	1275 lm	4000 K	60 deg
	FJ 131 015 2 F	White - Black	15	1275 lm	2700 K	60 deg
	FJ 131 015 3 F	White - Black	15	1275 lm	3000 K	60 deg
	FJ 131 015 4 F	White - Black	15	1275 lm	4000 K	60 deg

## Size 2

  <p>Length - 164 mm Breadth - 164 mm Height - 128 mm Cutout - 145 x 145</p>	FJ 112 025 2 S	White	25	2125 lm	2700 K	15 deg
	FJ 112 025 3 S	White	25	2125 lm	3000 K	15 deg
	FJ 112 025 4 S	White	25	2125 lm	4000 K	15 deg
	FJ 122 025 2 S	Black	25	2125 lm	2700 K	15 deg
	FJ 122 025 3 S	Black	25	2125 lm	3000 K	15 deg
	FJ 122 025 4 S	Black	25	2125 lm	4000 K	15 deg
	FJ 132 025 2 S	White - Black	25	2125 lm	2700 K	15 deg
	FJ 132 025 3 S	White - Black	25	2125 lm	3000 K	15 deg

## AEWIS



We reserve the right for technical and design changes  
For latest product update please refer [www.aewis.com](http://www.aewis.com)

# FJORD

recessed luminaires  
square | fixed

Article Reference	Finish	Watt	Lumen	Colour Temp	Beam Angle
FJ 132 025 4 S	White - Black	25	2125 lm	4000 K	15 deg
FJ 112 025 2 M	White	25	2125 lm	2700 K	38 deg
FJ 112 025 3 M	White	25	2125 lm	3000 K	38 deg
FJ 112 025 4 M	White	25	2125 lm	4000 K	38 deg
FJ 122 025 2 M	Black	25	2125 lm	2700 K	38 deg
FJ 122 025 3 M	Black	25	2125 lm	3000 K	38 deg
FJ 122 025 4 M	Black	25	2125 lm	4000 K	38 deg
FJ 132 025 2 M	White - Black	25	2125 lm	2700 K	38 deg
FJ 132 025 3 M	White - Black	25	2125 lm	3000 K	38 deg
FJ 132 025 4 M	White - Black	25	2125 lm	4000 K	38 deg
FJ 112 025 2 F	White	25	2125 lm	2700 K	60 deg
FJ 112 025 3 F	White	25	2125 lm	3000 K	60 deg
FJ 112 025 4 F	White	25	2125 lm	4000 K	60 deg
FJ 122 025 2 F	Black	25	2125 lm	2700 K	60 deg
FJ 122 025 3 F	Black	25	2125 lm	3000 K	60 deg
FJ 122 025 4 F	Black	25	2125 lm	4000 K	60 deg
FJ 132 025 2 F	White - Black	25	2125 lm	2700 K	60 deg
FJ 132 025 3 F	White - Black	25	2125 lm	3000 K	60 deg
FJ 132 025 4 F	White - Black	25	2125 lm	4000 K	60 deg

## Size 3

 Cut out 

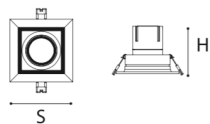

Length - 184 mm  
Breadth - 184 mm  
Height - 135 mm  
Cutout - 165 x 165

FJ 113 035 2 S	White	35	2975 lm	2700 K	15 deg
FJ 113 035 3 S	White	35	2975 lm	3000 K	15 deg
FJ 113 035 4 S	White	35	2975 lm	4000 K	15 deg
FJ 123 035 2 S	Black	35	2975 lm	2700 K	15 deg
FJ 123 035 3 S	Black	35	2975 lm	3000 K	15 deg
FJ 123 035 4 S	Black	35	2975 lm	4000 K	15 deg
FJ 133 035 2 S	White - Black	35	2975 lm	2700 K	15 deg
FJ 133 035 3 S	White - Black	35	2975 lm	3000 K	15 deg
FJ 133 035 4 S	White - Black	35	2975 lm	4000 K	15 deg
FJ 113 035 2 M	White	35	2975 lm	2700 K	38 deg
FJ 113 035 3 M	White	35	2975 lm	3000 K	38 deg
FJ 113 035 4 M	White	35	2975 lm	4000 K	38 deg
FJ 123 035 2 M	Black	35	2975 lm	2700 K	38 deg
FJ 123 035 3 M	Black	35	2975 lm	3000 K	38 deg
FJ 123 035 4 M	Black	35	2975 lm	4000 K	38 deg
FJ 133 035 2 M	White - Black	35	2975 lm	2700 K	38 deg

## AEWIS

We reserve the right for technical and design changes  
For latest product update please refer [www.aewis.com](http://www.aewis.com)

# FJORD

recessed luminaires  
square | fixed

Article Reference	Finish	Watt	Lumen	Colour Temp	Beam Angle
FJ 133 035 3 M	White - Black	35	2975 lm	3000 K	38 deg
FJ 133 035 4 M	White - Black	35	2975 lm	4000 K	38 deg
FJ 113 035 2 F	White	35	2975 lm	2700 K	60 deg
FJ 113 035 3 F	White	35	2975 lm	3000 K	60 deg
FJ 113 035 4 F	White	35	2975 lm	4000 K	60 deg
FJ 123 035 2 F	Black	35	2975 lm	2700 K	60 deg
FJ 123 035 3 F	Black	35	2975 lm	3000 K	60 deg
FJ 123 035 4 F	Black	35	2975 lm	4000 K	60 deg
FJ 133 035 2 F	White - Black	35	2975 lm	2700 K	60 deg
FJ 133 035 3 F	White - Black	35	2975 lm	3000 K	60 deg
FJ 133 035 4 F	White - Black	35	2975 lm	4000 K	60 deg

## Size 4

 Cut out 

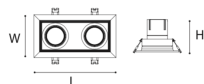

Length - 272 mm  
Breadth - 144 mm  
Height - 108 mm  
Cutout - 125 x 250

FJ 114 030 2 S	White	2 x 15	2550 lm	2700 K	15 deg
FJ 114 030 3 S	White	2 x 15	2550 lm	3000 K	15 deg
FJ 114 030 4 S	White	2 x 15	2550 lm	4000 K	15 deg
FJ 124 030 2 S	Black	2 x 15	2550 lm	2700 K	15 deg
FJ 124 030 3 S	Black	2 x 15	2550 lm	3000 K	15 deg
FJ 124 030 4 S	Black	2 x 15	2550 lm	4000 K	15 deg
FJ 134 030 2 S	White - Black	2 x 15	2550 lm	2700 K	15 deg
FJ 134 030 3 S	White - Black	2 x 15	2550 lm	3000 K	15 deg
FJ 134 030 4 S	White - Black	2 x 15	2550 lm	4000 K	15 deg
FJ 114 030 2 M	White	2 x 15	2550 lm	2700 K	38 deg
FJ 114 030 3 M	White	2 x 15	2550 lm	3000 K	38 deg
FJ 114 030 4 M	White	2 x 15	2550 lm	4000 K	38 deg
FJ 124 030 2 M	Black	2 x 15	2550 lm	2700 K	38 deg
FJ 124 030 3 M	Black	2 x 15	2550 lm	3000 K	38 deg
FJ 124 030 4 M	Black	2 x 15	2550 lm	4000 K	38 deg
FJ 134 030 2 M	White - Black	2 x 15	2550 lm	2700 K	38 deg
FJ 134 030 3 M	White - Black	2 x 15	2550 lm	3000 K	38 deg
FJ 134 030 4 M	White - Black	2 x 15	2550 lm	4000 K	38 deg
FJ 114 030 2 F	White	2 x 15	2550 lm	2700 K	60 deg
FJ 114 030 3 F	White	2 x 15	2550 lm	3000 K	60 deg
FJ 114 030 4 F	White	2 x 15	2550 lm	4000 K	60 deg
FJ 124 030 2 F	Black	2 x 15	2550 lm	2700 K	60 deg
FJ 124 030 3 F	Black	2 x 15	2550 lm	3000 K	60 deg
FJ 124 030 4 F	Black	2 x 15	2550 lm	4000 K	60 deg

## AEWIS

We reserve the right for technical and design changes  
For latest product update please refer [www.aewis.com](http://www.aewis.com)

# FJORD

recessed luminaires  
square | fixed

	Article Reference	Finish	Watt	Lumen	Colour Temp	Beam Angle
	FJ 134 030 2 F	White - Black	2 x 15	2550 lm	2700 K	60 deg
	FJ 134 030 3 F	White - Black	2 x 15	2550 lm	3000 K	60 deg
	FJ 134 030 4 F	White - Black	2 x 15	2550 lm	4000 K	60 deg

## Size 5

 Cut out 

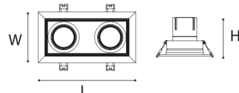

Length - 313 mm  
Breadth - 164 mm  
Height - 128 mm  
Cutout - 145 x 290

	FJ 115 050 2 S	White	2 x 25	4250 lm	2700 K	15 deg
	FJ 115 050 3 S	White	2 x 25	4250 lm	3000 K	15 deg
	FJ 115 050 4 S	White	2 x 25	4250 lm	4000 K	15 deg
	FJ 125 050 2 S	Black	2 x 25	4250 lm	2700 K	15 deg
	FJ 125 050 3 S	Black	2 x 25	4250 lm	3000 K	15 deg
	FJ 125 050 4 S	Black	2 x 25	4250 lm	4000 K	15 deg
	FJ 135 050 2 S	White - Black	2 x 25	4250 lm	2700 K	15 deg
	FJ 135 050 3 S	White - Black	2 x 25	4250 lm	3000 K	15 deg
	FJ 135 050 4 S	White - Black	2 x 25	4250 lm	4000 K	15 deg
	FJ 115 050 2 M	White	2 x 25	4250 lm	2700 K	38 deg
	FJ 115 050 3 M	White	2 x 25	4250 lm	3000 K	38 deg
	FJ 115 050 4 M	White	2 x 25	4250 lm	4000 K	38 deg
	FJ 125 050 2 M	Black	2 x 25	4250 lm	2700 K	38 deg
	FJ 125 050 3 M	Black	2 x 25	4250 lm	3000 K	38 deg
	FJ 125 050 4 M	Black	2 x 25	4250 lm	4000 K	38 deg
	FJ 135 050 2 M	White - Black	2 x 25	4250 lm	2700 K	38 deg
	FJ 135 050 3 M	White - Black	2 x 25	4250 lm	3000 K	38 deg
	FJ 135 050 4 M	White - Black	2 x 25	4250 lm	4000 K	38 deg
	FJ 115 050 2 F	White	2 x 25	4250 lm	2700 K	60 deg
	FJ 115 050 3 F	White	2 x 25	4250 lm	3000 K	60 deg
	FJ 115 050 4 F	White	2 x 25	4250 lm	4000 K	60 deg
	FJ 125 050 2 F	Black	2 x 25	4250 lm	2700 K	60 deg
	FJ 125 050 3 F	Black	2 x 25	4250 lm	3000 K	60 deg
	FJ 125 050 4 F	Black	2 x 25	4250 lm	4000 K	60 deg
	FJ 135 050 2 F	White - Black	2 x 25	4250 lm	2700 K	60 deg
	FJ 135 050 3 F	White - Black	2 x 25	4250 lm	3000 K	60 deg
	FJ 135 050 4 F	White - Black	2 x 25	4250 lm	4000 K	60 deg

## Size 6

	FJ 116 070 2 S	White	2 x 35	5950 lm	2700 K	15 deg
	FJ 116 070 3 S	White	2 x 35	5950 lm	3000 K	15 deg
	FJ 116 070 4 S	White	2 x 35	5950 lm	4000 K	15 deg
	FJ 126 070 2 S	Black	2 x 35	5950 lm	2700 K	15 deg

## AEWIS

We reserve the right for technical and design changes  
For latest product update please refer [www.aewis.com](http://www.aewis.com)



# FJORD

recessed luminaires  
square | fixed

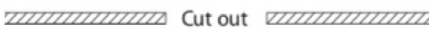
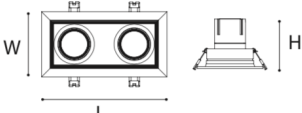
	Article Reference	Finish	Watt	Lumen	Colour Temp	Beam Angle
  Length - 345 mm Breadth - 184 mm Height - 135 mm Cutout - 165 x 330	FJ 126 070 3 S	Black	2 x 35	5950 lm	3000 K	15 deg
	FJ 126 070 4 S	Black	2 x 35	5950 lm	4000 K	15 deg
	FJ 136 070 2 S	White - Black	2 x 35	5950 lm	2700 K	15 deg
	FJ 136 070 3 S	White - Black	2 x 35	5950 lm	3000 K	15 deg
	FJ 136 070 4 S	White - Black	2 x 35	5950 lm	4000 K	15 deg
	FJ 116 070 2 M	White	2 x 35	5950 lm	2700 K	38 deg
	FJ 116 070 3 M	White	2 x 35	5950 lm	3000 K	38 deg
	FJ 116 070 4 M	White	2 x 35	5950 lm	4000 K	38 deg
	FJ 126 070 2 M	Black	2 x 35	5950 lm	2700 K	38 deg
	FJ 126 070 3 M	Black	2 x 35	5950 lm	3000 K	38 deg
	FJ 126 070 4 M	Black	2 x 35	5950 lm	4000 K	38 deg
	FJ 136 070 2 M	White - Black	2 x 35	5950 lm	2700 K	38 deg
	FJ 136 070 3 M	White - Black	2 x 35	5950 lm	3000 K	38 deg
	FJ 136 070 4 M	White - Black	2 x 35	5950 lm	4000 K	38 deg
	FJ 116 070 2 F	White	2 x 35	5950 lm	2700 K	60 deg
	FJ 116 070 3 F	White	2 x 35	5950 lm	3000 K	60 deg
	FJ 116 070 4 F	White	2 x 35	5950 lm	4000 K	60 deg
	FJ 126 070 2 F	Black	2 x 35	5950 lm	2700 K	60 deg
	FJ 126 070 3 F	Black	2 x 35	5950 lm	3000 K	60 deg
	FJ 126 070 4 F	Black	2 x 35	5950 lm	4000 K	60 deg
	FJ 136 070 2 F	White - Black	2 x 35	5950 lm	2700 K	60 deg
	FJ 136 070 3 F	White - Black	2 x 35	5950 lm	3000 K	60 deg
	FJ 136 070 4 F	White - Black	2 x 35	5950 lm	4000 K	60 deg

## Size 7

	Article Reference	Finish	Watt	Lumen	Colour Temp	Beam Angle
  Length - 400 mm Breadth - 144 mm Height - 108 mm Cutout - 125 x 375	FJ 117 045 2 S	White	3 x 15	3825 lm	2700 K	15 deg
	FJ 117 045 3 S	White	3 x 15	3825 lm	3000 K	15 deg
	FJ 117 045 4 S	White	3 x 15	3825 lm	4000 K	15 deg
	FJ 127 045 2 S	Black	3 x 15	3825 lm	2700 K	15 deg
	FJ 127 045 3 S	Black	3 x 15	3825 lm	3000 K	15 deg
	FJ 127 045 4 S	Black	3 x 15	3825 lm	4000 K	15 deg
	FJ 137 045 2 S	White - Black	3 x 15	3825 lm	2700 K	15 deg
	FJ 137 045 3 S	White - Black	3 x 15	3825 lm	3000 K	15 deg
	FJ 137 045 4 S	White - Black	3 x 15	3825 lm	4000 K	15 deg
	FJ 117 045 2 M	White	3 x 15	3825 lm	2700 K	38 deg
	FJ 117 045 3 M	White	3 x 15	3825 lm	3000 K	38 deg
	FJ 117 045 4 M	White	3 x 15	3825 lm	4000 K	38 deg

## AEWIS

We reserve the right for technical and design changes  
For latest product update please refer [www.aewis.com](http://www.aewis.com)

# FJORD

recessed luminaires  
square | fixed

Article Reference	Finish	Watt	Lumen	Colour Temp	Beam Angle
FJ 127 045 2 M	Black	3 x 15	3825 lm	2700 K	38 deg
FJ 127 045 3 M	Black	3 x 15	3825 lm	3000 K	38 deg
FJ 127 045 4 M	Black	3 x 15	3825 lm	4000 K	38 deg
FJ 137 045 2 M	White - Black	3 x 15	3825 lm	2700 K	38 deg
FJ 137 045 3 M	White - Black	3 x 15	3825 lm	3000 K	38 deg
FJ 137 045 4 M	White - Black	3 x 15	3825 lm	4000 K	38 deg
FJ 117 045 2 F	White	3 x 15	3825 lm	2700 K	60 deg
FJ 117 045 3 F	White	3 x 15	3825 lm	3000 K	60 deg
FJ 117 045 4 F	White	3 x 15	3825 lm	4000 K	60 deg
FJ 127 045 2 F	Black	3 x 15	3825 lm	2700 K	60 deg
FJ 127 045 3 F	Black	3 x 15	3825 lm	3000 K	60 deg
FJ 127 045 4 F	Black	3 x 15	3825 lm	4000 K	60 deg
FJ 137 045 2 F	White - Black	3 x 15	3825 lm	2700 K	60 deg
FJ 137 045 3 F	White - Black	3 x 15	3825 lm	3000 K	60 deg
FJ 137 045 4 F	White - Black	3 x 15	3825 lm	4000 K	60 deg

## Size 8

 Cut out 

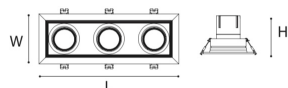

Length - 462 mm  
Breadth - 164 mm  
Height - 128 mm  
Cutout - 145 x 440

FJ 118 075 2 S	White	3 x 25	6375 lm	2700 K	15 deg
FJ 118 075 3 S	White	3 x 25	6375 lm	3000 K	15 deg
FJ 118 075 4 S	White	3 x 25	6375 lm	4000 K	15 deg
FJ 128 075 2 S	Black	3 x 25	6375 lm	2700 K	15 deg
FJ 128 075 3 S	Black	3 x 25	6375 lm	3000 K	15 deg
FJ 128 075 4 S	Black	3 x 25	6375 lm	4000 K	15 deg
FJ 138 075 2 S	White - Black	3 x 25	6375 lm	2700 K	15 deg
FJ 138 075 3 S	White - Black	3 x 25	6375 lm	3000 K	15 deg
FJ 4 075 138 S	White - Black	3 x 25	6375 lm	4000 K	15 deg
FJ 118 075 2 M	White	3 x 25	6375 lm	2700 K	38 deg
FJ 118 075 3 M	White	3 x 25	6375 lm	3000 K	38 deg
FJ 118 075 4 M	White	3 x 25	6375 lm	4000 K	38 deg
FJ 128 075 2 M	Black	3 x 25	6375 lm	2700 K	38 deg
FJ 128 075 3 M	Black	3 x 25	6375 lm	3000 K	38 deg
FJ 128 075 4 M	Black	3 x 25	6375 lm	4000 K	38 deg
FJ 138 075 2 M	White - Black	3 x 25	6375 lm	2700 K	38 deg
FJ 138 075 3 M	White - Black	3 x 25	6375 lm	3000 K	38 deg
FJ 138 075 4 M	White - Black	3 x 25	6375 lm	4000 K	38 deg
FJ 118 075 2 F	White	3 x 25	6375 lm	2700 K	60 deg
FJ 118 075 3 F	White	3 x 25	6375 lm	3000 K	60 deg

## AEWIS

We reserve the right for technical and design changes  
For latest product update please refer [www.aewis.com](http://www.aewis.com)

# FJORD

recessed luminaires  
square | fixed

Article Reference	Finish	Watt	Lumen	Colour Temp	Beam Angle
FJ 118 075 4 F	White	3 x 25	6375 lm	4000 K	60 deg
FJ 128 075 2 F	Black	3 x 25	6375 lm	2700 K	60 deg
FJ 128 075 3 F	Black	3 x 25	6375 lm	3000 K	60 deg
FJ 128 075 4 F	Black	3 x 25	6375 lm	4000 K	60 deg
FJ 138 075 2 F	White - Black	3 x 25	6375 lm	2700 K	60 deg
FJ 138 075 3 F	White - Black	3 x 25	6375 lm	3000 K	60 deg
FJ 138 075 4 F	White - Black	3 x 25	6375 lm	4000 K	60 deg

## Size 9

 Cut out 

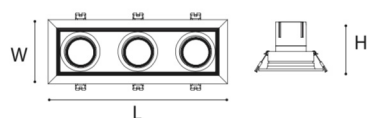

Length - 524 mm  
Breadth - 184 mm  
Height - 135 mm  
Cutout - 165 x 500

FJ 119 105 2 S	White	3 x 35	8925 lm	2700 K	15 deg
FJ 119 105 3 S	White	3 x 35	8925 lm	3000 K	15 deg
FJ 119 105 4 S	White	3 x 35	8925 lm	4000 K	15 deg
FJ 129 105 2 S	Black	3 x 35	8925 lm	2700 K	15 deg
FJ 129 105 3 S	Black	3 x 35	8925 lm	3000 K	15 deg
FJ 129 105 4 S	Black	3 x 35	8925 lm	4000 K	15 deg
FJ 139 105 2 S	White - Black	3 x 35	8925 lm	2700 K	15 deg
FJ 139 105 3 S	White - Black	3 x 35	8925 lm	3000 K	15 deg
FJ 4 105 139 S	White - Black	3 x 35	8925 lm	4000 K	15 deg
FJ 119 105 2 M	White	3 x 35	8925 lm	2700 K	38 deg
FJ 119 105 3 M	White	3 x 35	8925 lm	3000 K	38 deg
FJ 119 105 4 M	White	3 x 35	8925 lm	4000 K	38 deg
FJ 129 105 2 M	Black	3 x 35	8925 lm	2700 K	38 deg
FJ 129 105 3 M	Black	3 x 35	8925 lm	3000 K	38 deg
FJ 129 105 4 M	Black	3 x 35	8925 lm	4000 K	38 deg
FJ 139 105 2 M	White - Black	3 x 35	8925 lm	2700 K	38 deg
FJ 139 105 3 M	White - Black	3 x 35	8925 lm	3000 K	38 deg
FJ 4 105 139 M	White - Black	3 x 35	8925 lm	4000 K	38 deg
FJ 119 105 2 F	White	3 x 35	8925 lm	2700 K	60 deg
FJ 119 105 3 F	White	3 x 35	8925 lm	3000 K	60 deg
FJ 119 105 4 F	White	3 x 35	8925 lm	4000 K	60 deg
FJ 129 105 2 F	Black	3 x 35	8925 lm	2700 K	60 deg
FJ 129 105 3 F	Black	3 x 35	8925 lm	3000 K	60 deg
FJ 129 105 4 F	Black	3 x 35	8925 lm	4000 K	60 deg
FJ 139 105 2 F	White - Black	3 x 35	8925 lm	2700 K	60 deg
FJ 139 105 3 F	White - Black	3 x 35	8925 lm	3000 K	60 deg
FJ 139 105 4 F	White - Black	3 x 35	8925 lm	4000 K	60 deg

## AEWIS

We reserve the right for technical and design changes  
For latest product update please refer [www.aewis.com](http://www.aewis.com)

# FJORD

recessed luminaires  
square | fixed

## Light Distribution Curves

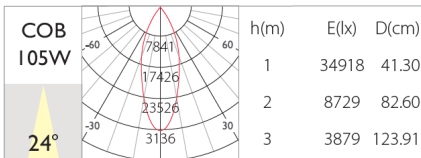
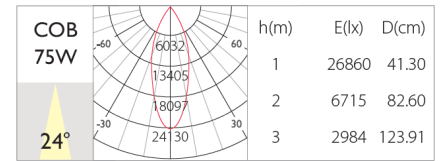
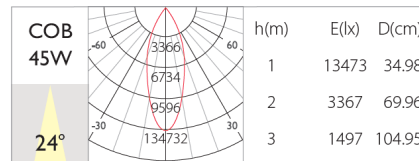
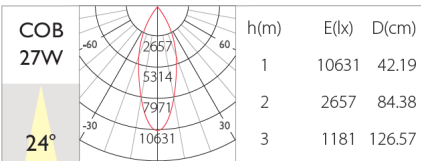
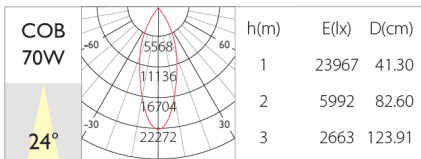
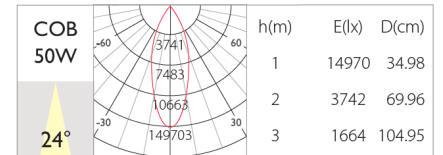
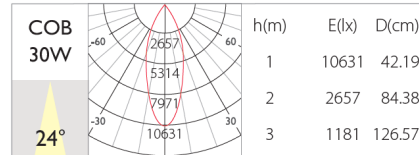
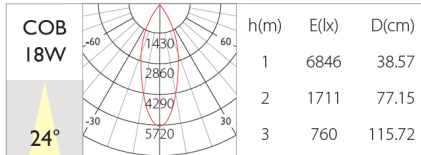
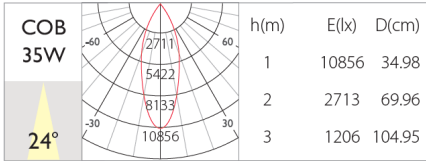
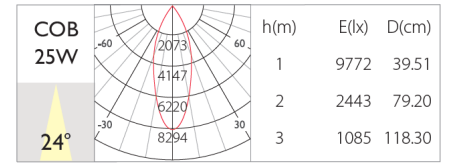
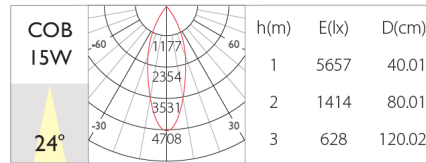
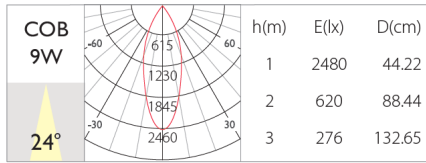

## AEWIS

We reserve the right for technical and design changes  
For latest product update please refer [www.aewis.com](http://www.aewis.com)

# 04 RECESSED LUMINAIRES

SQUARE | ADJUSTABLE

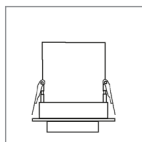

**VELOCE S**  
page