

## PACTEMONT



**04**

SIZES



**15 - 40**

WATTS



**03**

BEAM ANGLES



**IP 20**

INGRESS

# PACTEMONT

track light  
3 circuit | round

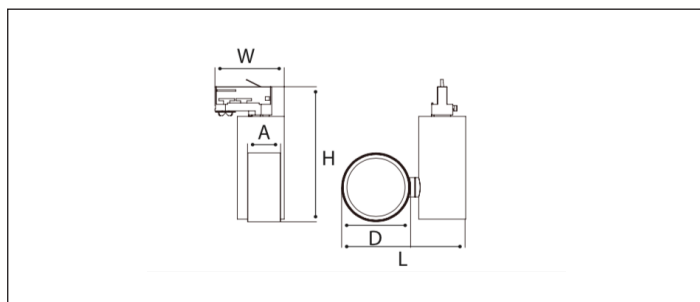

## Dimensions (mm)

	L	W	H	D/A
Size 1	179	105	200	95/49
Size 2	188	105	204	104/50

Pactemont 3-circuit track mounted Spot light collection offers options to choose from wattages ranging between 15W - 40W in all standard symmetric beam options and as made available across 2 varied size options to adopt to site requirements with 'single' and 'double' configurations' within the standard color spectrums.

The complete range is IP20 suitable for indoor applications as offered.

CCT of 5000K and 5700K are also available on request.

Standard protocol for fixed output driver is offered in our article coding. Dimmable driver options are available on request.

## Technical Data

**CREE** **bridgelux** **EPISTAR**

Body	Die Cast Aluminium
LED Type	COB
Colour Deviation	<2 SDCM
Colour Rendering Index	+90
Lumen Maintenance	L90 / B10 50000 hours
Driver	Integral
Dimmability	DALI (on request)
IP Rating	IP 20
Protection Class	Class II

## Certifications



## Available Options

Light Distribution		Watt	Lumen	Colour Temp	Finishes
10 deg	Spot (S)	15	1200	2700 K	White
	30 deg	20	1600		
20 deg	Medium (M)	25	2000	3000 K	Black
				4000 K	

## AEWIS

We reserve the right for technical and design changes  
For latest product update please refer [www.aewis.com](http://www.aewis.com)

# PACTEMONT

track light  
3 circuit | round | twin

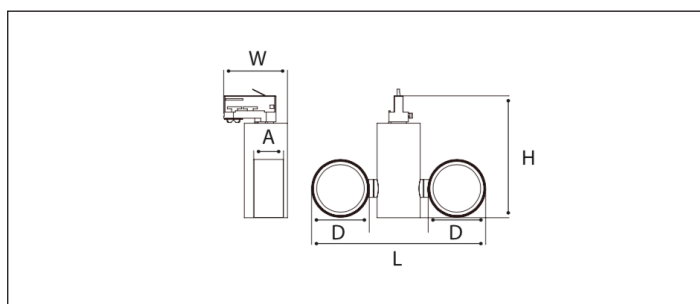

## Dimensions (mm)

	L	W	H	D/A
Size 1	287	105	200	95/49
Size 2	305	105	204	104/50

Pactemont 3-circuit track mounted Spot light collection offers options to choose from wattages ranging between 15W - 40W in all standard symmetric beam options and as made available across 2 varied size options to adopt to site requirements with 'single' and 'double' configurations' within the standard color spectrums.

The complete range is IP20 suitable for indoor applications as offered.

CCT of 5000K and 5700K are also available on request.

Standard protocol for fixed output driver is offered in our article coding. Dimmable driver options are available on request.

## Technical Data





**CREE**  **bridgelux**  **EPISTAR**

Body	Die Cast Aluminium
LED Type	COB
Colour Deviation	<2 SDCM
Colour Rendering Index	+90
Lumen Maintenance	L90 / B10 50000 hours
Driver	Integral
Dimmability	DALI (on request)
IP Rating	IP 20
Protection Class	Class II

## Certifications



## Available Options

Light Distribution		Watt	Lumen	Colour Temp	Finishes
10 deg	Spot (S)	2 x 15	2400	 2700 K	 White
	30 deg	2 x 20	3400	 3000 K	
20 deg	Medium (M)			 4000 K	 Black

## AEWIS

We reserve the right for technical and design changes  
For latest product update please refer [www.aewis.com](http://www.aewis.com)

# PACTEMONT

track light

3 circuit | round | twin

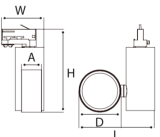
Size 1	Article Reference	Finish	Watt	Lumen	Colour Temp	Beam Angle
	PA 111 015 2 N	White	15	1200 lm	2700 K	10 deg
	PA 111 015 3 N	White	15	1200 lm	3000 K	10 deg
	PA 111 015 4 N	White	15	1200 lm	4000 K	10 deg
<p>Length - 179 mm Width - 105 mm Height - 200 mm</p>	PA 121 015 2 N	Black	15	1200 lm	2700 K	10 deg
	PA 121 015 3 N	Black	15	1200 lm	3000 K	10 deg
	PA 121 015 4 N	Black	15	1200 lm	4000 K	10 deg
	PA 131 015 2 N	White - Black	15	1200 lm	2700 K	10 deg
	PA 131 015 3 N	White - Black	15	1200 lm	3000 K	10 deg
	PA 131 015 4 N	White - Black	15	1200 lm	4000 K	10 deg
	PA 111 015 2 S	White	15	1200 lm	2700 K	20 deg
	PA 111 015 3 S	White	15	1200 lm	3000 K	20 deg
	PA 111 015 4 S	White	15	1200 lm	4000 K	20 deg
	PA 121 015 2 S	Black	15	1200 lm	2700 K	20 deg
	PA 121 015 3 S	Black	15	1200 lm	3000 K	20 deg
	PA 121 015 4 S	Black	15	1200 lm	4000 K	20 deg
	PA 131 015 2 S	White - Black	15	1200 lm	2700 K	20 deg
	PA 131 015 3 S	White - Black	15	1200 lm	3000 K	20 deg
	PA 131 015 4 S	White - Black	15	1200 lm	4000 K	20 deg
	PA 111 015 2 M	White	15	1200 lm	2700 K	30 deg
	PA 3 015 111 M	White	15	1200 lm	3000 K	30 deg
	PA 111 015 4 M	White	15	1200 lm	4000 K	30 deg
	PA 121 015 2 M	Black	15	1200 lm	2700 K	30 deg
	PA 121 015 3 M	Black	15	1200 lm	3000 K	30 deg
	PA 121 015 4 M	Black	15	1200 lm	4000 K	30 deg
	PA 131 015 2 M	White - Black	15	1200 lm	2700 K	30 deg
	PA 131 015 3 M	White - Black	15	1200 lm	3000 K	30 deg
	PA 131 015 4 M	White - Black	15	1200 lm	4000 K	30 deg
	PA 111 020 2 N	White	20	1600 lm	2700 K	10 deg
	PA 111 020 3 N	White	20	1600 lm	3000 K	10 deg
	PA 111 020 4 N	White	20	1600 lm	4000 K	10 deg
	PA 121 020 2 N	Black	20	1600 lm	2700 K	10 deg
	PA 121 020 3 N	Black	20	1600 lm	3000 K	10 deg
	PA 121 020 4 N	Black	20	1600 lm	4000 K	10 deg
	PA 131 020 2 N	White - Black	20	1600 lm	2700 K	10 deg
	PA 131 020 3 N	White - Black	20	1600 lm	3000 K	10 deg
	PA 131 020 4 N	White - Black	20	1600 lm	4000 K	10 deg

## AEWIS

We reserve the right for technical and design changes  
For latest product update please refer [www.aewis.com](http://www.aewis.com)

# PACTEMONT

track light

3 circuit | round | twin

Article Reference	Finish	Watt	Lumen	Colour Temp	Beam Angle
PA 111 020 2 S	White	20	1600 lm	2700 K	20 deg
PA 111 020 3 S	White	20	1600 lm	3000 K	20 deg
PA 111 020 4 S	White	20	1600 lm	4000 K	20 deg
PA 121 020 2 S	Black	20	1600 lm	2700 K	20 deg
PA 121 020 3 S	Black	20	1600 lm	3000 K	20 deg
PA 121 020 4 S	Black	20	1600 lm	4000 K	20 deg
PA 131 020 2 S	White - Black	20	1600 lm	2700 K	20 deg
PA 131 020 3 S	White - Black	20	1600 lm	3000 K	20 deg
PA 131 020 4 S	White - Black	20	1600 lm	4000 K	20 deg
PA 111 020 2 M	White	20	1600 lm	2700 K	30 deg
PA 111 020 3 M	White	20	1600 lm	3000 K	30 deg
PA 111 020 4 M	White	20	1600 lm	4000 K	30 deg
PA 121 020 2 M	Black	20	1600 lm	2700 K	30 deg
PA 121 020 3 M	Black	20	1600 lm	3000 K	30 deg
PA 121 020 4 M	Black	20	1600 lm	4000 K	30 deg
PA 131 020 2 M	White - Black	20	1600 lm	2700 K	30 deg
PA 131 020 3 M	White - Black	20	1600 lm	3000 K	30 deg
PA 131 020 4 M	White - Black	20	1600 lm	4000 K	30 deg

## Size 2

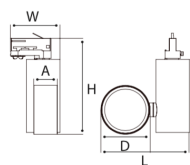

Length - 188 mm  
Width - 105 mm  
Height - 204 mm

PA 2 025 112 N	White	25	2000 lm	2700 K	10 deg
PA 112 025 3 N	White	25	2000 lm	3000 K	10 deg
PA 112 025 4 N	White	25	2000 lm	4000 K	10 deg
PA 122 025 2 N	Black	25	2000 lm	2700 K	10 deg
PA 122 025 3 N	Black	25	2000 lm	3000 K	10 deg
PA 122 025 4 N	Black	25	2000 lm	4000 K	10 deg
PA 132 025 2 N	White - Black	25	2000 lm	2700 K	10 deg
PA 132 025 3 N	White - Black	25	2000 lm	3000 K	10 deg
PA 132 025 4 N	White - Black	25	2000 lm	4000 K	10 deg
PA 112 025 2 S	White	25	2000 lm	2700 K	20 deg
PA 112 025 3 S	White	25	2000 lm	3000 K	20 deg
PA 112 025 4 S	White	25	2000 lm	4000 K	20 deg
PA 122 025 2 S	Black	25	2000 lm	2700 K	20 deg
PA 122 025 3 S	Black	25	2000 lm	3000 K	20 deg
PA 122 025 4 S	Black	25	2000 lm	4000 K	20 deg
PA 132 025 2 S	White - Black	25	2000 lm	2700 K	20 deg
PA 132 025 3 S	White - Black	25	2000 lm	3000 K	20 deg

## AEWIS

We reserve the right for technical and design changes  
For latest product update please refer [www.aewis.com](http://www.aewis.com)

# PACTEMONT

track light

3 circuit | round | twin

Article Reference	Finish	Watt	Lumen	Colour Temp	Beam Angle
PA 132 025 4 S	White - Black	25	2000 lm	4000 K	20 deg
PA 112 025 2 M	White	25	2000 lm	2700 K	30 deg
PA 112 025 3 M	White	25	2000 lm	3000 K	30 deg
PA 112 025 4 M	White	25	2000 lm	4000 K	30 deg
PA 122 025 2 M	Black	25	2000 lm	2700 K	30 deg
PA 122 025 3 M	Black	25	2000 lm	3000 K	30 deg
PA 122 025 4 M	Black	25	2000 lm	4000 K	30 deg
PA 132 025 2 M	White - Black	25	2000 lm	2700 K	30 deg
PA 132 025 3 M	White - Black	25	2000 lm	3000 K	30 deg
PA 132 025 4 M	White - Black	25	2000 lm	4000 K	30 deg

## Size 3

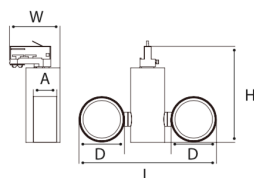

Length - 287 mm  
Width - 105 mm  
Height - 200 mm

PA 113 030 2 N	White	2 x 15	2400 lm	2700 K	10 deg
PA 113 030 3 N	White	2 x 15	2400 lm	3000 K	10 deg
PA 113 030 4 N	White	2 x 15	2400 lm	4000 K	10 deg
PA 123 030 2 N	Black	2 x 15	2400 lm	2700 K	10 deg
PA 123 030 3 N	Black	2 x 15	2400 lm	3000 K	10 deg
PA 123 030 4 N	Black	2 x 15	2400 lm	4000 K	10 deg
PA 133 030 2 N	White - Black	2 x 15	2400 lm	2700 K	10 deg
PA 133 030 3 N	White - Black	2 x 15	2400 lm	3000 K	10 deg
PA 4 030 133 N	White - Black	2 x 15	2400 lm	4000 K	10 deg
PA 113 030 2 S	White	2 x 15	2400 lm	2700 K	20 deg
PA 113 030 3 S	White	2 x 15	2400 lm	3000 K	20 deg
PA 113 030 4 S	White	2 x 15	2400 lm	4000 K	20 deg
PA 123 030 2 S	Black	2 x 15	2400 lm	2700 K	20 deg
PA 123 030 3 S	Black	2 x 15	2400 lm	3000 K	20 deg
PA 123 030 4 S	Black	2 x 15	2400 lm	4000 K	20 deg
PA 133 030 2 S	White - Black	2 x 15	2400 lm	2700 K	20 deg
PA 133 030 3 S	White - Black	2 x 15	2400 lm	3000 K	20 deg
PA 133 030 4 S	White - Black	2 x 15	2400 lm	4000 K	20 deg
PA 113 030 2 M	White	2 x 15	2400 lm	2700 K	30 deg
PA 113 030 3 M	White	2 x 15	2400 lm	3000 K	30 deg
PA 113 030 4 M	White	2 x 15	2400 lm	4000 K	30 deg
PA 123 030 2 M	Black	2 x 15	2400 lm	2700 K	30 deg
PA 123 030 3 M	Black	2 x 15	2400 lm	3000 K	30 deg
PA 123 030 4 M	Black	2 x 15	2400 lm	4000 K	30 deg
PA 133 030 2 M	White - Black	2 x 15	2400 lm	2700 K	30 deg

## AEWIS

We reserve the right for technical and design changes  
For latest product update please refer [www.aewis.com](http://www.aewis.com)

# PACTEMONT

track light

3 circuit | round | twin

Article Reference	Finish	Watt	Lumen	Colour Temp	Beam Angle
PA 133 030 3 M	White - Black	2 x 15	2400 lm	3000 K	30 deg
PA 133 030 4 M	White - Black	2 x 15	2400 lm	4000 K	30 deg

## Size 4

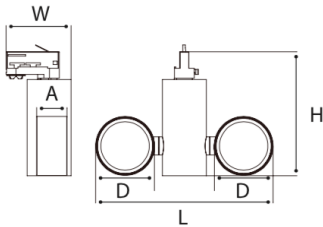

Length - 305 mm  
Width - 105 mm  
Height - 204 mm

PA 114 040 2 N	White	2 x 20	3400 lm	2700 K	10 deg
PA 114 040 3 N	White	2 x 20	3400 lm	3000 K	10 deg
PA 114 040 4 N	White	2 x 20	3400 lm	4000 K	10 deg
PA 124 040 2 N	Black	2 x 20	3400 lm	2700 K	10 deg
PA 124 040 3 N	Black	2 x 20	3400 lm	3000 K	10 deg
PA 124 040 4 N	Black	2 x 20	3400 lm	4000 K	10 deg
PA 134 040 2 N	White - Black	2 x 20	3400 lm	2700 K	10 deg
PA 134 040 3 N	White - Black	2 x 20	3400 lm	3000 K	10 deg
PA 134 040 4 N	White - Black	2 x 20	3400 lm	4000 K	10 deg
PA 114 040 2 S	White	2 x 20	3400 lm	2700 K	20 deg
PA 114 040 3 S	White	2 x 20	3400 lm	3000 K	20 deg
PA 114 040 4 S	White	2 x 20	3400 lm	4000 K	20 deg
PA 124 040 2 S	Black	2 x 20	3400 lm	2700 K	20 deg
PA 124 040 3 S	Black	2 x 20	3400 lm	3000 K	20 deg
PA 124 040 4 S	Black	2 x 20	3400 lm	4000 K	20 deg
PA 134 040 2 S	White - Black	2 x 20	3400 lm	2700 K	20 deg
PA 3 040 134 S	White - Black	2 x 20	3400 lm	3000 K	20 deg
PA 134 040 4 S	White - Black	2 x 20	3400 lm	4000 K	20 deg
PA 114 040 2 M	White	2 x 20	3400 lm	2700 K	30 deg
PA 114 040 3 M	White	2 x 20	3400 lm	3000 K	30 deg
PA 114 040 4 M	White	2 x 20	3400 lm	4000 K	30 deg
PA 124 040 2 M	Black	2 x 20	3400 lm	2700 K	30 deg
PA 124 040 3 M	Black	2 x 20	3400 lm	3000 K	30 deg
PA 124 040 4 M	Black	2 x 20	3400 lm	4000 K	30 deg
PA 134 040 2 M	White - Black	2 x 20	3400 lm	2700 K	30 deg
PA 134 040 3 M	White - Black	2 x 20	3400 lm	3000 K	30 deg
PA 134 040 4 M	White - Black	2 x 20	3400 lm	4000 K	30 deg

## AEWIS

We reserve the right for technical and design changes  
For latest product update please refer [www.aewis.com](http://www.aewis.com)

# PACTEMONT

track light

3 circuit | round | twin

## Light Distribution Curves

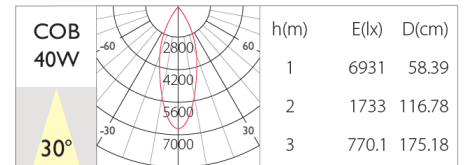
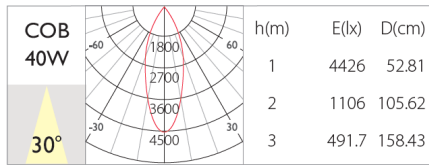
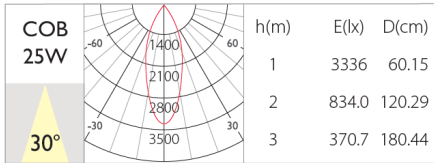
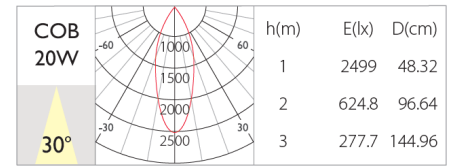
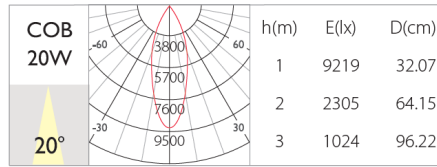
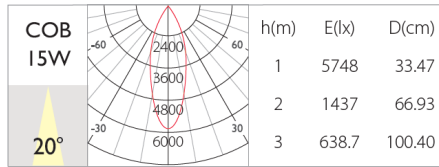

## AEWIS

We reserve the right for technical and design changes  
For latest product update please refer [www.aewis.com](http://www.aewis.com)